

Modular Cooking Range Line 700XP 4- Hot Round Plates Electric Boiling Top on Electric Oven - Marine

ITEM # _____

MODEL # _____

NAME # _____

SIS # _____

AIA # _____

371148 (E7ECMH4RE5)

 4-Hot Plate (2,6 kW each)
 electric Range on electric
 Oven (6 kW) - marine

Short Form Specification

Item No.

To be installed on stainless steel feet with height adjustment up to 50 mm. Four 2.6 kW cast-iron hot plates hermetically sealed to the one-piece top. Stainless steel oven chamber with 3 levels of runners to accommodate 2/1 GN shelves (2 steam pans). Ribbed oven base plate. Exterior panels in stainless steel with Scotch Brite finish. One piece pressed work top in 1.5 mm thick stainless steel. Right-angled side edges to allow flush-fitting junction between units.

Main Features

- The four round 2.6kW cast-iron plates are hermetically sealed to the one-piece top.
- Base compartment consists of an electric standard oven with thick oven door for heat insulation, positioned beneath the base plate.
- Electric oven to have separate thermostats for top and bottom heating elements.
- Stainless steel oven chamber with 3 levels of runners to accommodate 2/1 GN shelves (2 steam pans).
- Ribbed enamelled steel oven base plate.
- The special design of the control knob system guarantees against water infiltration.
- IPx4 water protection.
- Oven thermostat adjustable from 100 °C to 300 °C.

Construction

- All exterior panels in Stainless Steel with Scotch Brite finishing.
- One piece pressed 1.5 mm work top in Stainless steel.
- Model has right-angled side edges to allow flush fitting joints between units, eliminating gaps and possible dirt traps.

Included Accessories

- 1 of GN2/1 chrome grid for static oven PNC 164250

Optional Accessories

- GN2/1 chrome grid for static oven PNC 164250
- Junction sealing kit PNC 206086
- Kit 4 wheels - 2 swivelling with brake - it is mandatory to install Base support and wheels PNC 206135
- Flanged feet kit PNC 206136
- Frontal kicking strip for concrete installation, 800mm PNC 206148
- Frontal kicking strip for concrete installation, 1200mm PNC 206151
- Frontal kicking strip for concrete installation, 1600mm PNC 206152
- Frontal kicking strip, 800mm (not for refr-freezer base) PNC 206176
- Frontal kicking strip, 1000mm (not for refr-freezer base) PNC 206177
- Frontal kicking strip, 1200mm (not for refr-freezer base) PNC 206178
- Frontal kicking strip, 1600mm (not for refr-freezer base) PNC 206179
- Kit 4 feet for concrete installation (not for 900 line free standing grill) PNC 206210
- Pair of side kicking strips PNC 206249
- Pair of side kicking strips for concrete installation PNC 206265

APPROVAL: _____



Electrolux
PROFESSIONAL

Modular Cooking Range Line 700XP 4- Hot Round Plates Electric Boiling Top on Electric Oven - Marine

- Water column with swivel arm (water column extension not included) PNC 206289
- Water column extension for 700 line PNC 206291
- Right and left side handrails PNC 206307
- Back handrail 800 mm PNC 206308
- Back handrail 1200 mm PNC 206309
- Base support for feet or wheels - 800mm (700/900) PNC 206367
- Base support for feet or wheels - 1200mm (700/900) PNC 206368
- Base support for feet or wheels - 1600mm (700/900) PNC 206369
- Base support for feet or wheels - 2000mm (700/900) PNC 206370
- Rear paneling - 800mm (700/900) PNC 206374
- Rear paneling - 1000mm (700/900) PNC 206375
- Rear paneling - 1200mm (700/900) PNC 206376
- Chimney grid net, 400mm (700XP/900) PNC 206400
- 2 side covering panels for free standing appliances PNC 216000
- Frontal handrail, 800mm PNC 216047
- Frontal handrail, 1200mm PNC 216049
- Frontal handrail, 1600mm PNC 216050
- Large handrail - portioning shelf, 800mm PNC 216186



Modular Cooking Range Line
700XP 4- Hot Round Plates Electric Boiling Top on Electric Oven -
Marine
The company reserves the right to make modifications to the products
without prior notice. All information correct at time of printing.

2025.01.22

Front

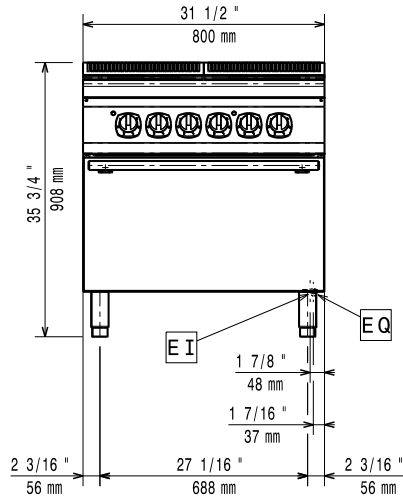

Side

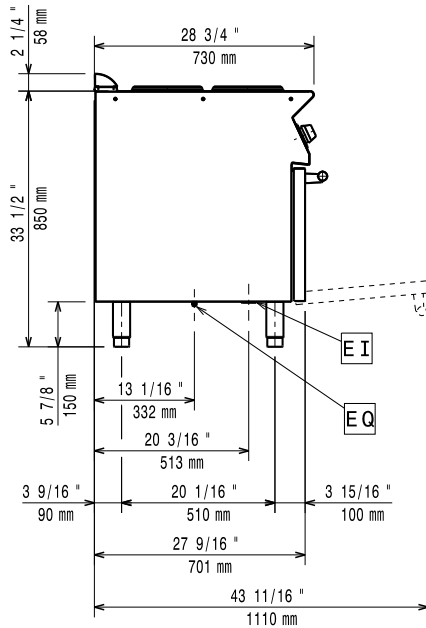

EI = Electrical inlet (power)
 EQ = Equipotential screw

Top

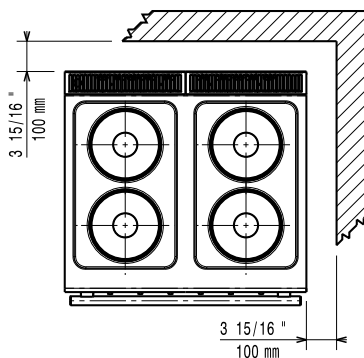

Electric

Supply voltage:

371148 (E7ECMH4RE5) 400 V/3 ph/50/60 Hz

Electrical power max.:

16.4 kW

Key Information:

Front Plates Power:	2.6 - 2.6 kW
Back Plates Power:	2.6 - 2.6 kW
Front Plates dimensions:	Ø 230 Ø 230
Back Plates dimensions:	Ø 230 Ø 230
Oven Heat Input:	6 kW
Oven working Temperature:	100 °C MIN; 300 °C MAX
Oven Cavity Dimensions (width):	540 mm
Oven Cavity Dimensions (height):	300 mm
Oven Cavity Dimensions (depth):	650 mm
External dimensions, Width:	800 mm
External dimensions, Depth:	730 mm
External dimensions, Height:	850 mm
Net weight:	80 kg
Certification group:	N7CE1
Waterproof index:	IPX4